



EV-D2ICR36-TY



## 2-Wire IP Video Intercom Kit User Manual



## Contents

1. Install wiring .....	1
1.1 Installation diagram .....	1
1.2 Connect the Outdoor station and indoor Monitor .....	3
2. Indoor Monitor operation .....	6
2.1 System Setting .....	6
2.2 Outdoor Monitor real-time screen .....	10
2.3 Call records .....	11
2.4 Mobile detection records .....	12
3. Tuya APP remote control .....	13
3.1 Download and install Tuya APP .....	13
3.2 Account registration and login .....	13
3.3 Add Devices .....	16
3.4 View real-time pictures .....	19
3.5 Calling and remote unlocking .....	23
3.6 Help and Service .....	24

# 1. Install wiring

## 1.1 Installation diagram

The video intercom should be installed at a height of 1.4 to 1.7 meters above the ground. Try to avoid sun and rain. Use screws or tape to fix it on the wall, wooden board, door.

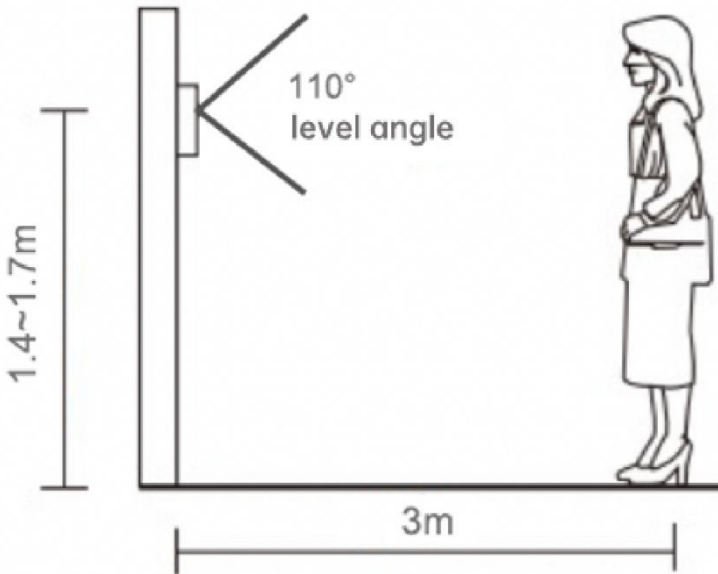

Image 1-1 Outdoor Station Installation Diagram

## Device Installation Diagram

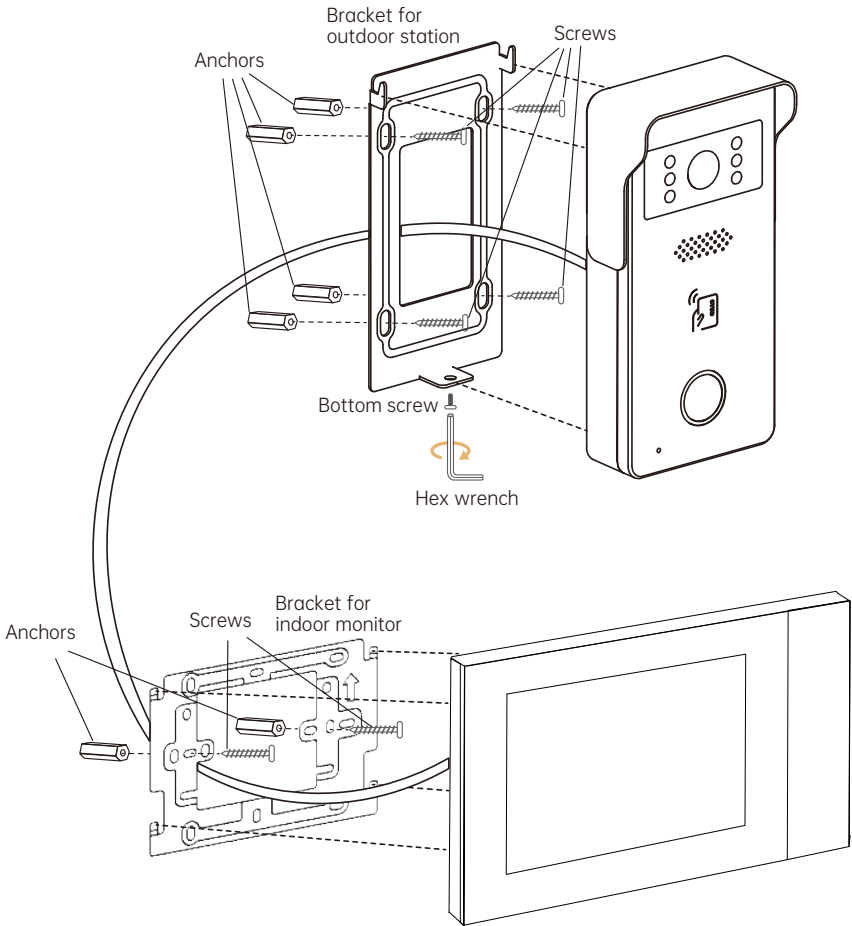

Image 1-2 Device Installation Diagram

Avoiding harsh environments: The visitor (Outdoor Station) intercom system should not be installed in areas exposed to direct sunlight, high temperatures, rain, snow, chemical corrosion, excessive humidity, or excessive dust.

## 1.2 Connect the Outdoor station and indoor Monitor

### Standard Connection Diagram

#### 1 Set Outdoor Station to 1 Set Indoor Monitor

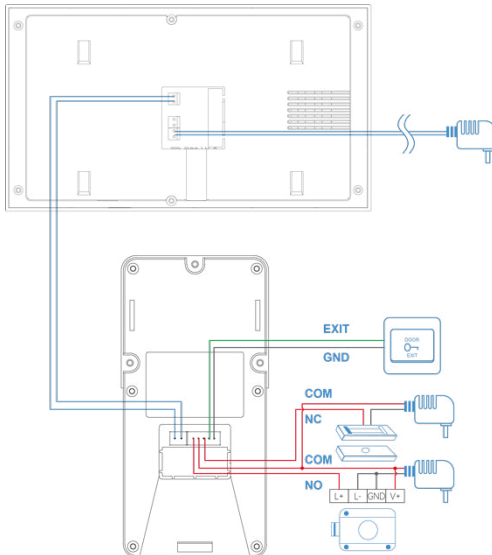

Image 1-3 Standard Connection Diagram 1 Set Outdoor Station to 1 Set Indoor Monitor

#### 1 Set Outdoor Station to 2 Set Indoor Monitor

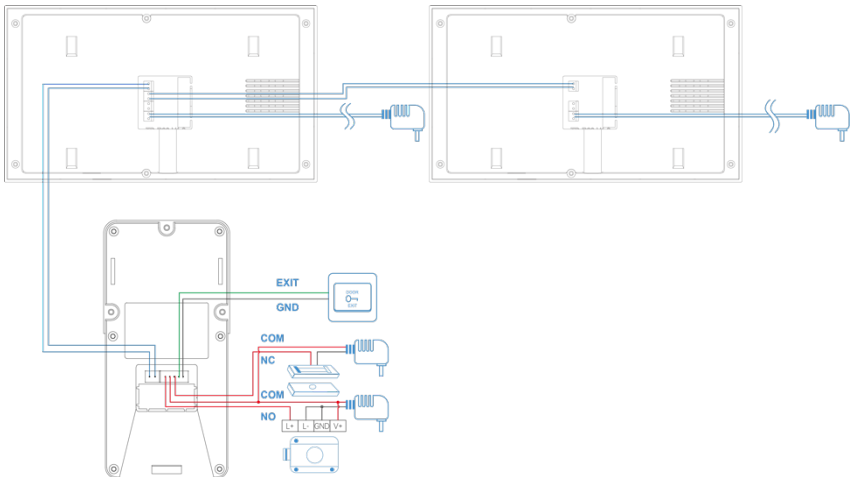

Image 1-4 Standard Connection Diagram 1 Set Outdoor Station to 2 Set Indoor Monitor

## 2 Set Outdoor Station to 1 Set Indoor Monitor

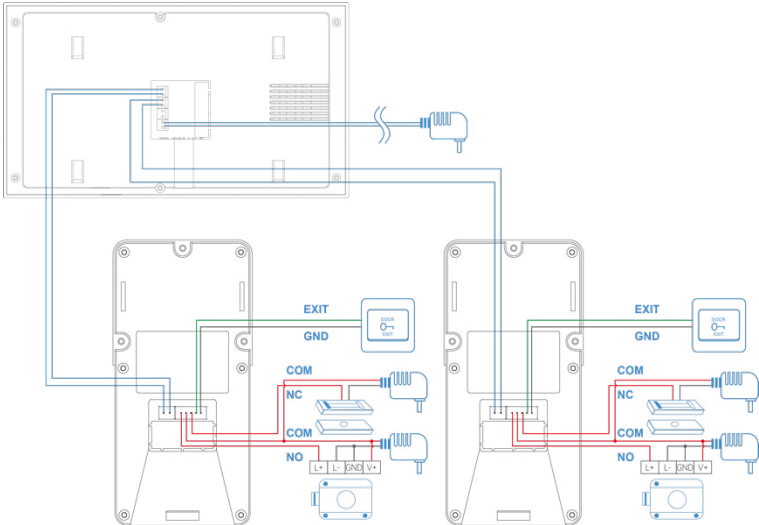

Image 1-5 Standard Connection Diagram 2 Set Outdoor Station to 1 Set Indoor Monitor

## Access Control Power Connection Diagram

### 1 Set Outdoor Station to 1 Set Indoor Monitor

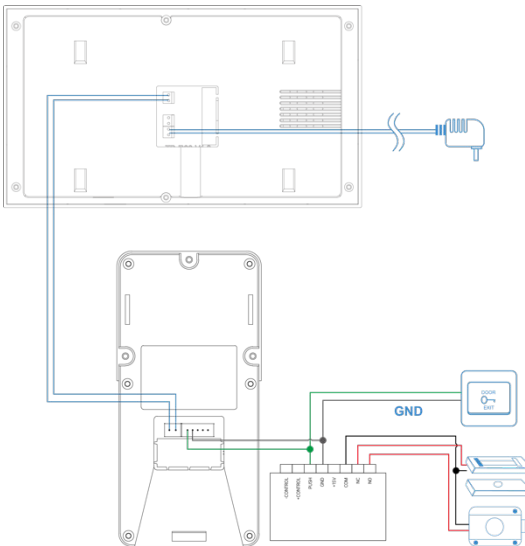

Image 1-6 Access Control Power Connection Diagram 1 Set Outdoor Station to 1 Set Indoor Monitor

## 1 Set Outdoor Station to 2 Set Indoor Monitor

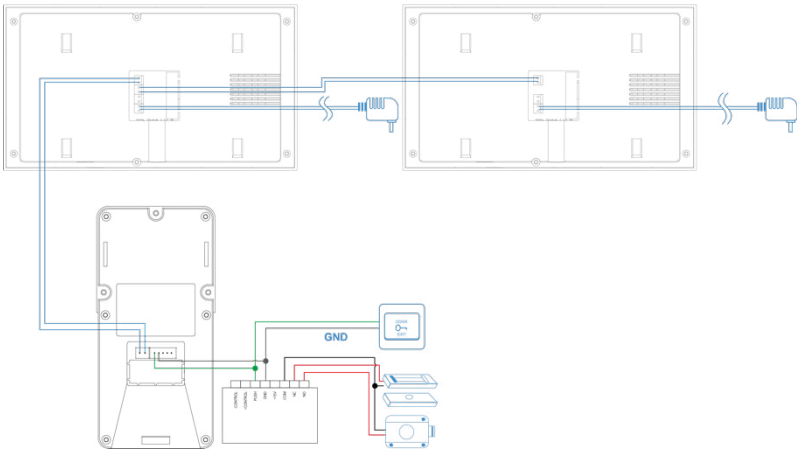

Image 1-7 Access Control Power Connection Diagram 1 Set Outdoor Station to 2 Set Indoor Monitor

## 2 Set Outdoor Station to 1 Set Indoor Monitor

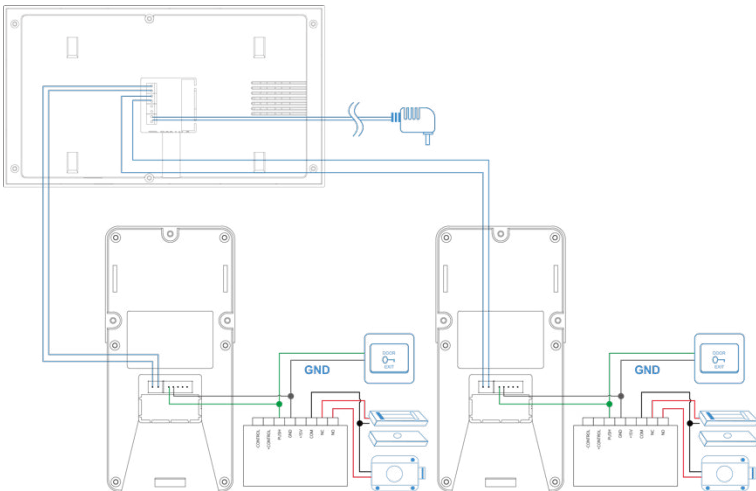

Image 1-8 Access Control Power Connection Diagram 2 Set Outdoor Station to 1 Set Indoor Monitor

Connect the outdoor station to the indoor monitor according to the diagram, without distinguishing positive and negative poles (non-polar);  
Secure the connection terminals;  
Connect to the power supply.

## 2. Indoor Monitor operation

Main Interface:



Image 2-1 indoor monitor operation main interface

### 2.1 System Setting

Enter Main Interface and click  then enter system setting interface.

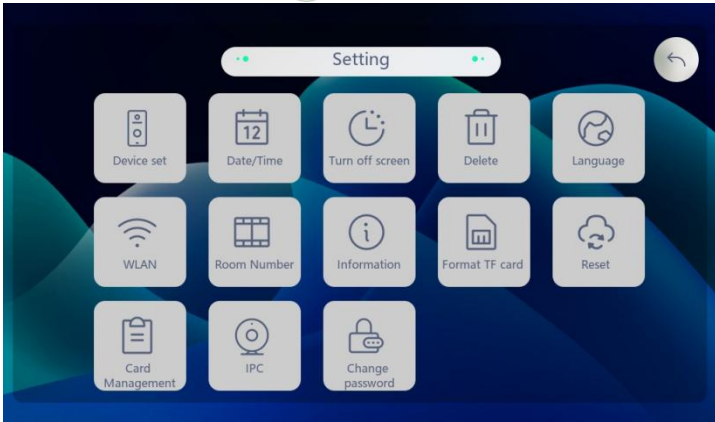

Image 2-2 indoor monitor system setting

1. Device set: Click and select one outdoor station to enter the outdoor station setting interface.

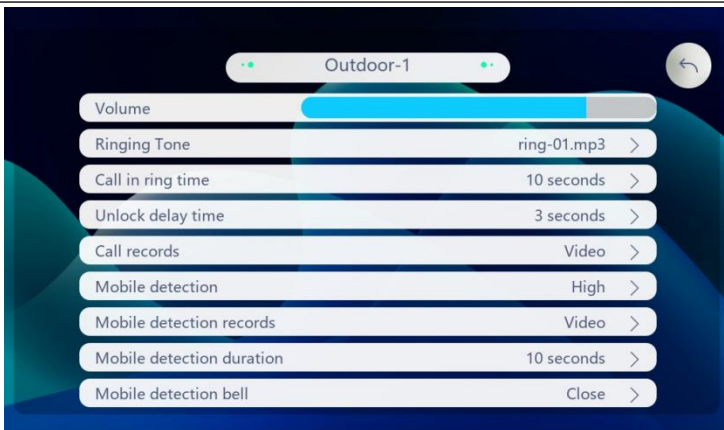

Image 2-3 outdoor station setting interface

**Volume:**

Set the indoor monitor ringtone volume.

**Ringing Tone:**

8 kinds of ringtones to choose from, click to audition.

**Call in ring time:**

1s~120s.

**Unlock delay time:**

Set the delay time of unlocking(1 s~10 s).

**Call records:**

Set the way to record when a visitor calls.

**Mobile detection:**

Set the motion detection sensitivity (close, low, medium, high); After turning on motion detection, when the door station detects someone moving, it  will appear in the upper right corner of the main interface.

**Mobile detection records:**

Set the recording method to take photos or videos when the outdoor station detects someone moving.

**Mobile detection duration:**

When the recording method of motion detection is video recording, you can set the video recording duration here, and the selectable range is from 10 s~300 s.

**Mobile detection bell:**

8 kinds of ringtone options.

2. Date/Time: Set the time format and modify the synchronization time mode to automatic or manual. In the manual time synchronization state, you can set the time, date, and time zone.
3. Turn off screen: Set screen off time.
4. Delete: Delete photo or video history.
5. Language: multiple languages.
6. WLAN: Connect the indoor monitor to WiFi. For specific operations, see 3.3 Adding Devices.
7. Room Number: Switch the host and slave room numbers.
8. Information: View indoor monitor information, IP address, MAC address, UUID number , TF Card Capacity.
9. Format TF card.
10. Reset: Reset to factory default.
11. Card management:

To add or delete a card, click and enter the password to proceed.

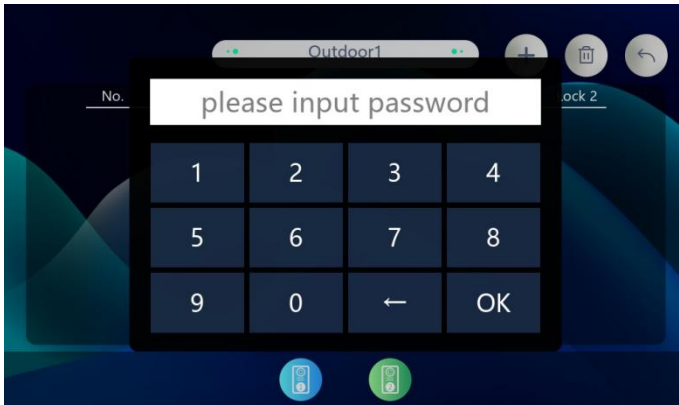







Image 2-4 Card management

  : Switch the outdoor station.

Add the card: Click the  to enter the card-swiping state, then add the card through the outdoor station, click the  to return to the card manage interface, you can view the added card.

Delete Card: Click the  to enter the card-swiping state, then delete the card through the outdoor station, click the  to return to the card manage interface, you can view the deleted card or click on the card number to be deleted.

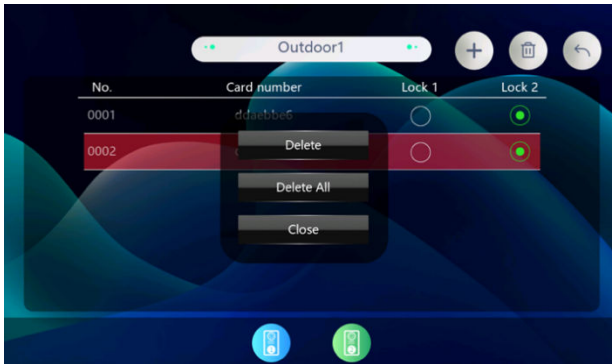

Image 2-5 Card management

12. IPC:



Image 2-6 IPC

onvif search for IPC (must set IPC sub-stream, only supports H264, resolution below 720P)

13. Change Password:

The factory default password is "666666" and the fixed super password is "168168".

## 2.2 Outdoor Monitor real-time screen

Enter Main Interface and click  then enter Real-time monitoring screen.

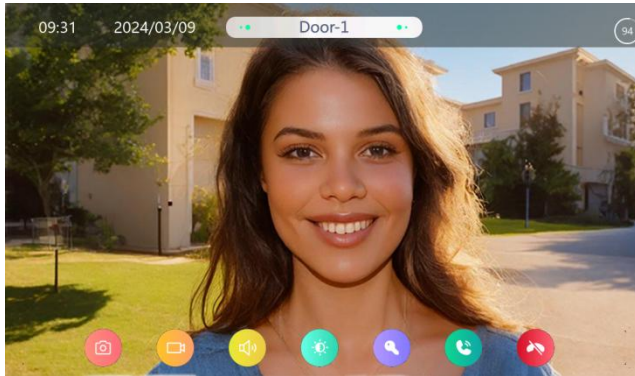









Image 2-7 Real-time monitoring screen

-  : Take photos and record
-  : Take video recording
-  : Adjust volume
-  : Set brightness, contrast, saturation
-  : unlock
-  : answer
-  : hang up

### 2.3 Call records

Click the  to view call records.

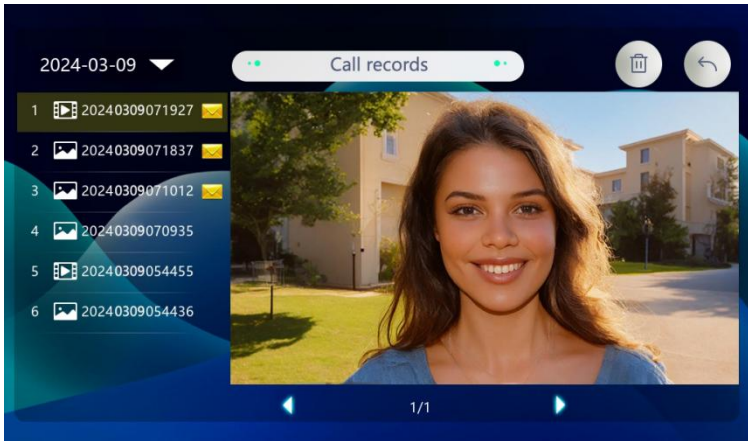

Image 2-8 call records

## 2.4 Mobile detection records

Click the  to mobile detection records.



Image 2-9 mobile detection records

## 3.Tuya APP remote control

### 3.1 Download and install Tuya APP

1. Search and download "Tuya Smart" or "Smart Life" in the mobile app store.
2. Scan the QR code below to download the APP.



Image 3-1 Tuya Smart QR code

Image 3-2 Smart Life QR code

### 3.2 Account registration and login

1. Please click to register if you are using "Tuya Smart" or "Smart Life" APP for the first time.
2. If you have already registered an account, you can log in directly through your mobile phone number or authorize your login through your WeChat account or Apple ID .

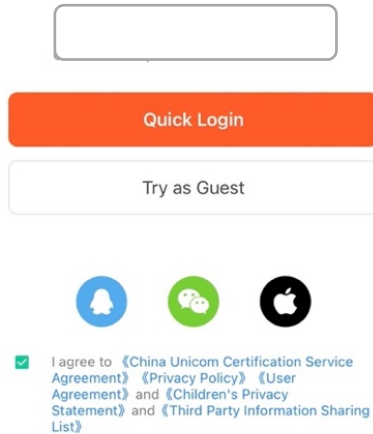

Image 3-3 Account registration and login

3. In order to ensure the normal use of APP functions, please allow and open all permissions of APP before use.

4. After logging in the APP, you can choose to create a family first and then add devices.

How to create a family: Click "My - Family Management - Create Family" in the lower right corner of the homepage, fill in the information and save it. The setter will automatically become the family owner and can set up administrators and ordinary members. When a family owner or administrator adds a device, family members will automatically add the device.

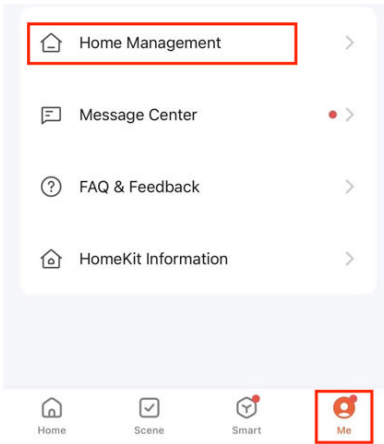

Image 3-4 family management

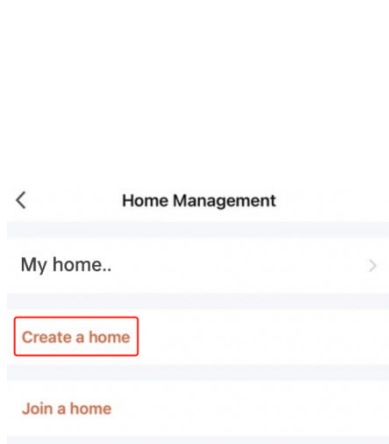

Image 3-5 create family

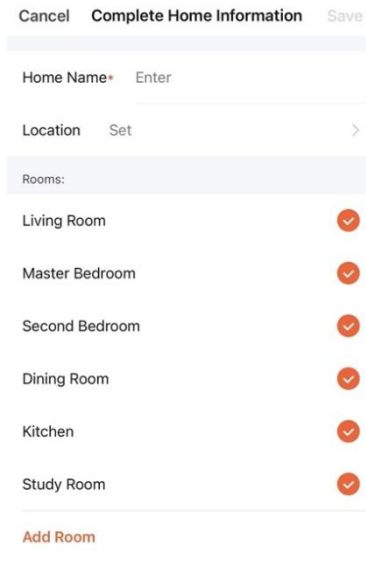

Image 3-6 complete home information

5. "Tuya Smart" or "Smart Life" is a large platform that can add multiple categories of smart products. Compared with the shared account, all family members who add this device have more unlocking functions; up to 20 administrators and family members can be added to a single family.
6. The video intercom is the device with a high security level. The device

must be removed from the original account before it can be bound to a new account.

### 3.3 Add Devices

1. The indoor monitor is connected to WiFi.

To configure the network for the indoor monitor, click [Settings] — [WLAN] on the main interface to enter the network configuration interface. It will prompt "WiFi connection successful", indicating that the indoor monitor is successfully connected to the Internet and the device QR code is displayed in the upper right corner.



Image 3-7 connected to WiFi



Image 3-8 device QR code

2. Open the Tuya app and click [Add Device].

3. Click on the upper right corner to scan the QR code of the device in the indoor unit [WLAN] .
4. When the search is completed, click [Add].You need to wait for a while during the process of adding equipment.
5. The device name can be customized.
6. Click Add to complete and enter the monitoring interface.
7. The device appears in the device list.

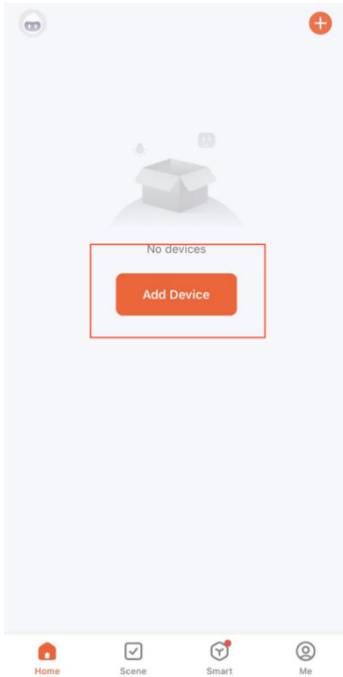

Image 3-9 Add Device

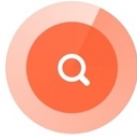

Image 3-10 scan the QR code



### Connecting Device

Make sure your device is near the router.



01:45

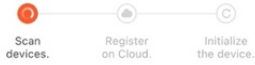

Image 3-11 connecting device



### Add Device

1 device(s) added successfully



Security Camera  
Added successfully

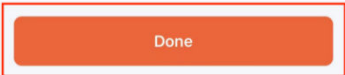

Image 3-12 the device name can be customized

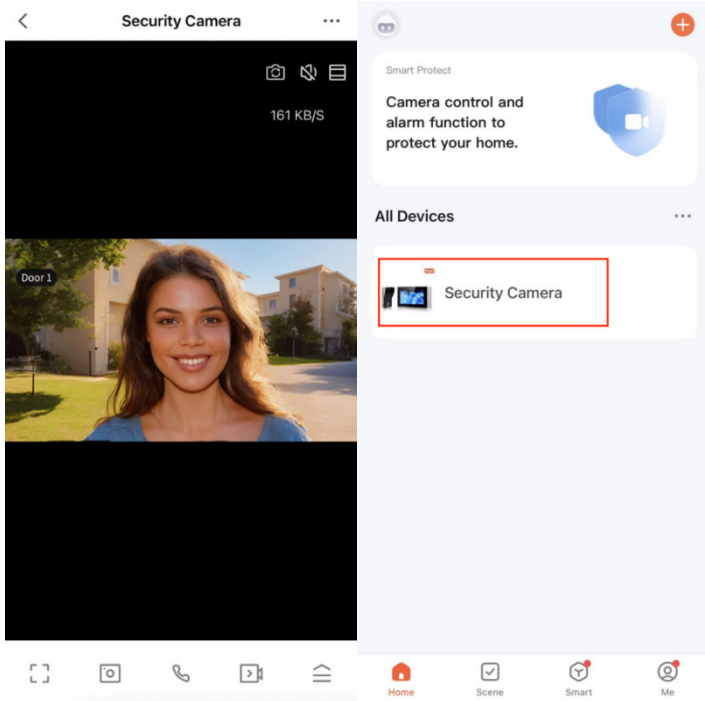

Image 3-13 monitoring interface

Image 3-14 The device appears in the device list

### 3.4 View real-time pictures

Click the device to enter the real-time screen, you can switch to outdoor station, mute, screen magnification, floating window operation, photo, intercom, video, unlock, playback, photo album, switch theme color, click the upper right corner to make more settings.

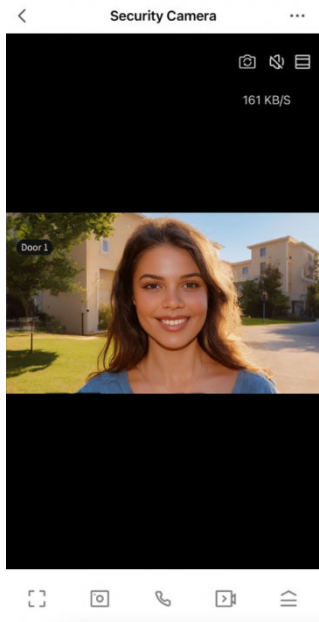



Image 3-15 View real-time pictures

1.

 : Switch to outdoor station

 : switch to mute

 : screen magnification

2. Message: Displays motion detection alarm messages and photo records when someone rings the doorbell.

3. Function:

**Playback:**

Click for real-time screen playback

**Photo Album:**

Store photos and videos.

**Theme color matching:**

Provides two theme colors, bright mode and dark mode, for users to choose from.

**Motion detection:**

can detect moving objects near the camera and generate alarm information.

**Lock:**

The lock can be unlocked remotely and a record of the unlocking time can be generated.

**Edit:**

Manage interface function keys and home device shortcut keys.

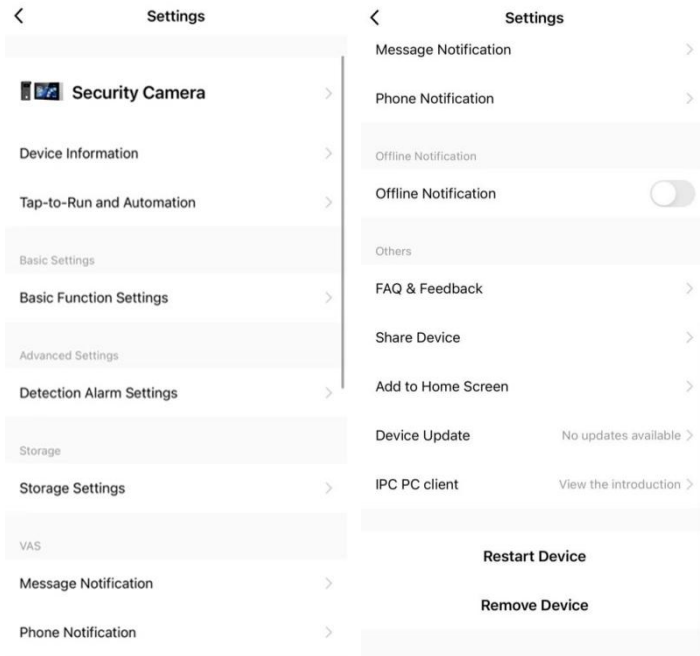

Image 3-16 security camera setting

1. Device: Modify the device name and location.
2. Device information: View IP address, device ID, signal strength and device time zone.
3. "One-click execution" and "automation": You can create intelligent scenes in "Scenes". After setting the "automation" scene, the device can

be automatically controlled for you, saving trouble and worry; after setting the "one-click execution" scene, in Manually click to control the device in the APP, which is fast and convenient.

4. Basic function settings: control the status indicator light switch of the door station, whether the screen is flipped, and add time watermark.

5. Detection alarm setting: Motion detection alarm switch, after turning it on, you can set the alarm sensitivity (low, medium, high); you can also set the alarm time period.

6.Storage settings: View the capacity, used capacity, and remaining capacity of the memory card; you can also format the memory card.

7. Value-added services: After activating the rights, you can add phone and text message notifications through APP scene automation or message center - alarm management. When your scene automation is successfully executed or an alarm occurs on the device, you will be notified via phone calls and text messages. Important No messages are missed, and your devices and home are protected in real time.

8. Offline reminder: The alarm message list will be pushed to the APP after the device is offline for more than 30 minutes (low-power devices will trigger a reminder after more than 8 hours).

9. Others:

### **Frequently Asked Questions and Feedback:**

You can view some frequently asked questions to quickly provide help to users who are unfamiliar with the product or software operation.

### **Share device:**

Enter the mobile phone number or email address of the user you want to share with, and click "Finish"; or enter the number of people

you want to share with and then select the sharing method to share; you can also directly copy the device information and share it with others. It should be noted that shared users cannot unlock. The unlocking user must be a family member. Members added in family management have full permissions on the menu.

**Add to desktop:**

You can add the device to the desktop.

**Device upgrade:**

Check the current software version; you can turn on the automatic upgrade function, and the device will automatically upgrade, but important function upgrades still need to be confirmed.

**PC computer client:**

View the introduction of IPC workstation. (Visit <https://protect.ismartlife.me> with Chrome browser on the computer, and use the mobile APP to scan the QR code to log in)

- 10. Restart the device: Restart the device.
- 11. Remove the device: After this account removes the device, other accounts or mobile phones can connect to the device.

### **3.5 Calling and remote unlocking**

- 1. When a visitor presses the doorbell, it will be pushed online:

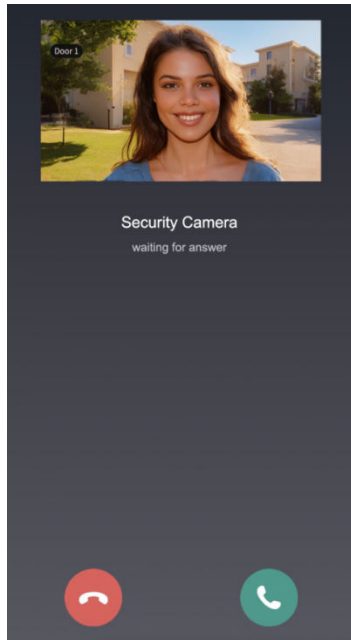

Image 3-17 pushed online

Click to answer or hang up. After answering, the real-time screen will be entered. Users can perform intercom, take photos, video, remotely unlock and other operations.

2. The mobile phone's standby status is pushed as follows:

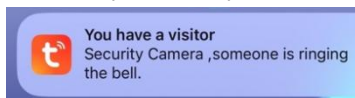

Image 3-18 pushed as follows

Click on the push message to enter the real-time screen, and users can perform operations such as intercom, photo taking, video recording, and remote unlocking.

## 3.6 Help and Service

Tuya has many smart products, you can click [My] to enter service and

help.

1. "Voice third-party service", you can choose multiple intelligent voice control products, and each third-party product has detailed connection tutorials.
2. "Family Management" can create a new family or join a family and set permissions.
3. "Message Center" can view alarm information, family information and related notifications.
4. You can familiarize yourself with APP usage and device operation by viewing "Help and Feedback".

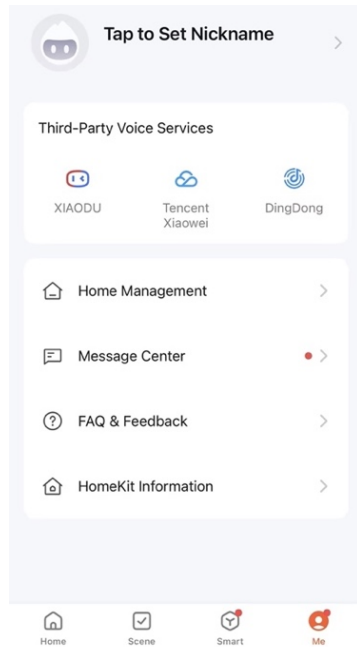

Image 3-19 help and service

# Eurovision

EV-D2ICR36-TY



[www.eurovisioniot.com](http://www.eurovisioniot.com)

